

Accessori - Accessories



TERMINALI STANDARD

Standard end terminal
Standardendstücke
Extrémité standard
Terminal estándar

Terminale a manina 2 onde

2-waves fish tail
2 Wellen Fishtail-Endstück
Extrémité à queue de carpe 2-ondes
Terminal cola de pez bi-onda

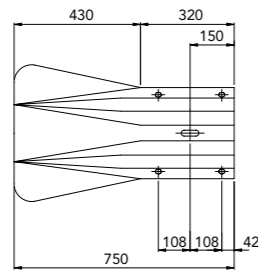

material	cod.
ZC	59600134

Terminale a manina 3 onde

3-waves fish tail
3 Wellen Fishtail-Endstück
Extrémité à queue de carpe 3-ondes
Terminal cola de pez triple-onda

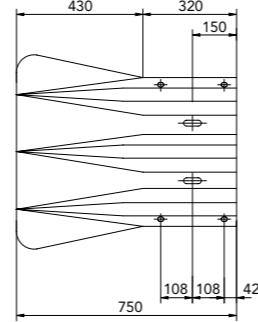

material	cod.
ZC	59600136

Terminale a tubo 2 onde

Tube 2-waves end terminal
2 Wellen Fussgänger-Endstück mit Endrohr
Glissière tubulaire
d'extrémité 2-ondes
Terminal tubular bi-onda

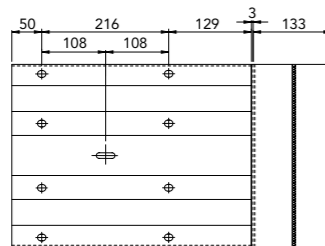

material	cod.
ZC	59600442

Terminale a tubo 3 onde

Tube 3-waves end terminal
3 Wellen Fussgänger-Endstück mit Endrohr
Glissière tubulaire
d'extrémité 3-ondes
Terminal tubular triple-onda

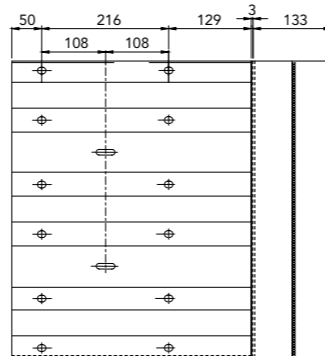

material	cod.
ZC	59600218

Terminale angolare per mitred 2 onde

2 waves angle beam
for mitred end terminal
2 Wellen Endabsenkung
Mitred Winkelverbindung
Manchon incliné
d'extrémité
2-ondes
Pieza angular
bi-onda
de abatimiento

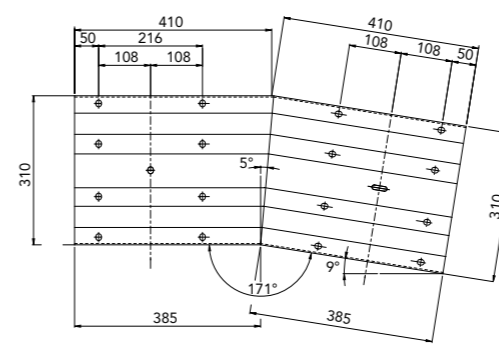

material	cod.
ZC	59600229

Terminale angolare per mitred 3 onde

3 waves angle beam
for mitred end terminal
3 Wellen Endabsenkung
Mitred Winkelverbindung
Manchon incliné
d'extrémité 3-ondes
Pieza angular
triple-onda
de abatimiento

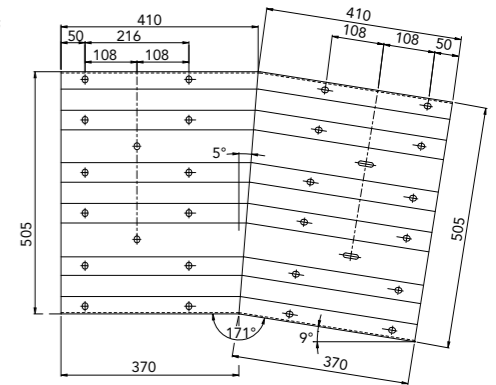

material	cod.
ZC	59600191

Terminale piatto per cemento 2 onde

Flat 2-waves end terminal for concrete
2 Wellen flacher Endstück für Beton/Wand
Extrémité à queue de carpe plate 2-ondes
Terminal plano bi-onda

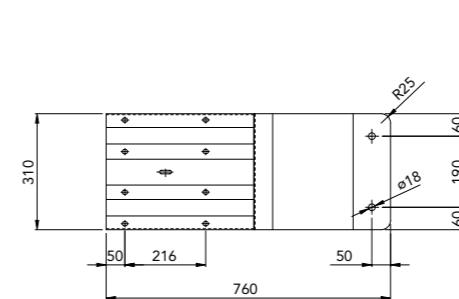

material	cod.
ZC	59600586

Terminale piatto per cemento 3 onde

Flat 3-waves end terminal for concrete
3 Wellen flacher Endstück für Beton/Wand
Extrémité à queue de carpe plate 3-ondes
Terminal plano triple-onda

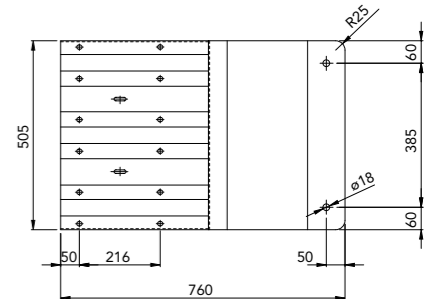

material	cod.
ZC	59600161

Differenti tipologie di terminali sono disponibili secondo le reali richieste
Different types of end terminal might be produced according to the requirements